

Article number: 203160M1245C4X
 Description: E+G levelling foot
 GN 31-60-M12-45-C4-X
 Note: X With female thread, External hexagon

Measures

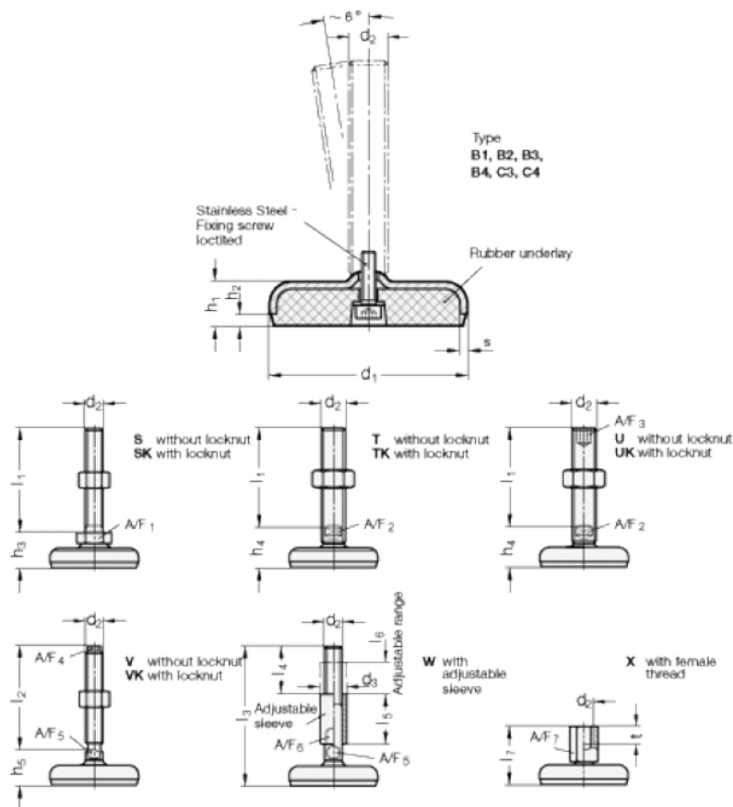

A/F7	= 17
d1	= 60
d2	= 12
h1	= 16
h2	= 4
l7 +4.0/0	= 45
s	= 3
t	= 12